



Electronic
TUBE

Ham News

Copyright 1951, by General Electric Company



MAY—JUNE 1951

VOL. 6—NO. 3

TRANSMITTER TUBE TESTING

Simplified Test Procedures for Popular Transmitting Tubes



TEST INSTRUCTIONS FOR:

- | | |
|----------------|---------|
| GL-2E26 | GL-810 |
| GL-4D21/4-125A | GL-811A |
| GL-4-250A/5D22 | GL-812A |
| GL-35T | GL-813 |
| GL-100TH | GL-814 |
| GL-203A | GL-815 |
| GL-211 | GL-829B |
| GL-592 | GL-832A |
| GL-805 | GL-837 |
| GL-806 | GL-838 |
| GL-807 | GL-8000 |

GL-8005



Whenever you suspect that a receiving tube is bad, you either plug in a new one (if you have a spare) or you make a trip to see your serviceman friend and use his tube tester. However, when something has gone wrong in your transmitter, you hesitate to try your spare transmitting tube in place of the suspect tube, and you certainly will not find a transmitting tube tester handy.

Or, if the ham in the next block wants to trade some tubes with you, you may end up with some low emission tubes that are good only for future trading with another unsuspecting ham.

All of the above points out the fact that it would be extremely nice to be able to test a transmitting tube when the need arises. It is the purpose of this article to explain how to run some simple (hence non-conclusive) tests on your favorite bottle.

GENERAL TESTING COMMENTS

Vacuum tube manufacturers spend a great deal of time and money in order to test their product completely. A transmitting tube such as the GL-813, for example, may have to pass twenty or more tests before it is considered good enough to bear the G-E trade-

mark. Many of the individual test sets used to run these tests will each be worth more than an elaborate ham transmitter.

Obviously, therefore, any simple tests which the amateur is able to run will not do as complete a job of quality testing as the tests the manufacturers make. However, the simple tests about to be described will permit the ham to roughly evaluate the quality of his transmitting tubes, and in most cases, these simple tests will give a true indication of whether the tube is generally good or generally bad.

It is possible for these simple tests to call a bad tube good, and a good tube bad, especially if the tests are not carefully conducted, but these cases will be the exception, so the following simple tests should give you a wealth of information about the quality of your transmitting tubes.

TUBE TYPES CONSIDERED

Testing instructions are given for most of the popular and widely used amateur tubes (see list above). If a certain type is not included, it is either because the testing would be more complicated and

Contents

Transmitter Tube Testing	pages 1-6
Sweeping the Spectrum	page 7
R-F Power Indicator	page 8

involve special apparatus; or, it is a high-power type not deemed necessary to include.

TEST INSTRUCTIONS

Three different tests are suggested for each tube type. The first is a short and continuity test, the second a static characteristic test, and the third either an oscillation test or a limited peak emission test, depending on tube type. It will be necessary to run all three tests in order to completely test any particular tube.

Run the tests in order. If a tube fails Test I because of an internal short, there is no point in making any further tests. However, if a tube passes Test I and fails Test II, you could still run Test III to see if the tube has any emission, even though Test II showed you that the static characteristic of the tube was poor.

If the tests are to mean anything, you must run them carefully. Use accurate meters. Follow the instructions exactly.

For tests II and III, allow the filament to heat for five minutes before proceeding with the test.

TEST I

The data for Test I is given on page 3. The purpose of this test is to determine filament continuity and to check for undesirable shorts. The base connection diagram for each tube is shown. These diagrams are made looking at the bottom of the tube, with the base pins facing you.

Use an ohmmeter to check continuity. *Do not* use a lamp in series with the a-c line as a continuity indicator, as you may damage the filament of the tube. An ohmmeter with a range of zero to 50,000 ohms or zero to 250,000 ohms, or anything in that range will be satisfactory. It is not advisable to use an ohmmeter scale which will read too high a resistance, such as ten megohms or so, because you are looking for continuity and shorts, and not for leakage.

Check for filament continuity first, then check for shorts by probing between a given pin and all other pins, then another pin against all other pins, etc. If a pin is marked NC, for no connection, check it anyway to make certain no continuity exists. All electrodes, including grid and anode caps (if any), should be tested for continuity or shorts.

Consider a tube to have passed this test if you have filament continuity, and continuity between other electrodes as shown on the diagram—and, if all other electrodes are floating, that is, have no continuity to any other electrodes.

TEST II

The data for this test is given on page 4. The purpose of this test is to determine, approximately, the static characteristic of the tube in question. In other words, it is a check on the controlling ability of the grid (or grids). This test is intended to show up a grid that has been bent out of place due to dropping a tube, for example. Many other small internal faults may also be determined. This test *does not* show whether a tube has low emission, or is near the end of life.

All tubes are not tested in the same manner. One group (Test II-A) must have the grid bias adjusted until the plate current measures a predetermined value, then the grid bias voltage must be read to determine if it falls in the "good" range. The other group (Test II-B) must have the grid bias voltage set to a certain value, then the resultant plate current must fall within a certain "good" range.

The circuit diagram for the test set-up is shown in Fig. 1 on page 4. If the tube you are testing has no

cathode, disregard the cathode connection shown. Similarly, if the tube is a triode, disregard the dotted screen-grid lead. (One tube, the GL-837, requires a suppressor voltage. See note B on page 4.)

It is not necessary to construct a separate test set for Test II. You may use a socket in a rig you already have. Just remove, temporarily, the grid, screen grid and plate leads, and connect as shown in Fig. 1. It is desirable to be able to vary the filament voltage, so that it may be set exactly at the voltage specified in column 1, page 4.

To test a tube in the II-A group, apply filament voltage, apply a grid bias which is midway in the specified range, then apply plate voltage (and screen voltage if the tube is not a triode). Check the plate current and readjust grid bias until the plate current is as specified, then read the grid bias voltage you are using. The tube is "good" if the grid bias voltage is within the limits shown.

To test a tube in the II-B group, apply filament voltage, apply the exact grid bias voltage shown, and apply plate (and screen) voltage. Read plate current. The tube is "good" if the plate current is within the limits shown.

TEST III

The data for Test III-A is given on page 5, and that for Test III-B is given on page 6. Seventeen tubes are listed for the former test, and six tubes are more easily tested by the latter test. Test III-A is a power oscillation test, in which the tube is operating at 14 megacycles. Test III-B is a test which checks for the total emission, under the conditions shown, for a very brief moment.

The diagram on page 5 shows the test set-up necessary for Test III-A. This is a Hartley oscillator circuit. Because this test is run at a reduced filament voltage, it is absolutely necessary that a variable control be used in the filament circuit. This control need not be an autotransformer, as shown, but some sort of stepless control is needed.

In the circuit diagram for this test, the 0.005 mf condensers must have a voltage rating consistent with the tube being tested. They should be capable of handling the d-c plate voltage (E_B) plus some safety factor. The 0.005 mf condenser in the screen circuit should handle the d-c screen voltage (E_S), plus a safety factor. The two 0.002 mf condensers should be rated at 400 or 600 volts breakdown.

The tank coil should have an inductance of approximately 5 microhenrys. A regular 20 meter transmitting coil will serve, as long as the wire in the coil is bare, so that the proper point for the tap can be located.

If you already have a transmitter using the tube in question, it is not necessary to provide an oscillator circuit, as you may use the tube as an amplifier and run the test. In this case the tube must be run at as high a plate (and screen) voltage as specified, else the results will only be valid for the lower voltage you use.

To run Test III-A, put the tube in the circuit as shown, and turn on the filament, setting the control to give normal voltage. Make certain a dummy load is coupled to the tank, and apply plate (and screen) voltage. If the control grid current (I_C) is not as specified, adjust the tap on the coil (*with power off*) until the grid current is as specified.

Adjust the dummy load coupling (see *Ham News*, Vol. 6, No. 1, page 6 for a discussion of dummy loads), until the proper plate current (I_B) is being drawn, according to the table. Readjust the tap for proper grid current. Next, measure power output in some manner, and reduce the filament voltage until the power output drops down 10%. Read filament voltage. If this voltage is below the figure stated in

column 7 on page 5, the tube is "good." If the voltage is more than the stated figure, the tube is "bad."

(Power output may be read in a comparative manner by the device shown on page 8.)

If a tube passes Test III-A, you know that the tube has some life left in it. The lower the filament voltage reading, the better the emission. This test will permit you to compare the emission of two tubes quite easily.

If you use your transmitter for the test set, Test III-A is run in a similar manner. Turn on the filaments, wait five minutes, then apply grid drive until I_C is as specified. Apply plate (and screen) voltage and adjust your dummy load until I_B is as specified. Measure power output, lower filament voltage until this power drops to 90% of the original value, then read filament voltage.

When running test III-A, watch the tube envelope. If a bluish glow appears which seems to fill most of the envelope, the tube is gassy and hence "bad." Under these circumstances, plate and screen currents may run extremely high.

Test III-B is a different sort of test, but it gives

you approximately the same information as Test III-A. In Test III-B all electrodes except cathode (and/or filament) are connected together, then a positive voltage is applied to the electrodes, and the total current measured. Caution must be employed when running this test, as the grid will be damaged if the voltage is applied for more than a second or so.

To run this test, connect the tube as shown in Fig. 3. Apply the filament voltage specified in column 1, page 6, and allow the filament to heat for five minutes. Make certain you are using the right plate voltage (column 2, page 6) then throw the switch. The instant the plate current meter settles down, make a mental note of the reading and turn the switch off. *Under no circumstances should the plate voltage be applied for more than four seconds.*

If the current for a new tube is greater than the value indicated in column 4, page 6, then the tube is "good." If the current for a used tube is greater than the value specified in column 3, page 6, then the used tube is "good." If I_T is below this last figure, the tube is "bad." Tubes which have total currents (I_T) which are approximately the same value have approximately the same emission.

TEST I Continuity and Short Test

INSTRUCTIONS:

Use ohmmeter as discussed previously. Refer to proper diagram, below, and check for filament continuity, including filament or heater center-taps (if any). Check between other points where continuity should exist. Check the remainder of the pins, each to all others, to see if a short exists. Reject tube if undesired shorts exist or if continuity is not found where it should exist.

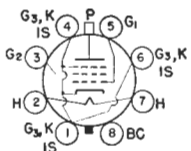

GL-2E26

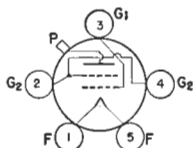

GL-4D21/4-125A
GL-4-250A/5D22

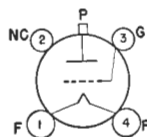

GL-35T

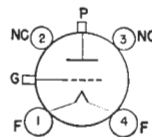

GL-100TH

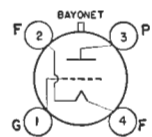

GL-203A GL-211
GL-838

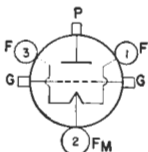

GL-592

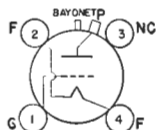

GL-805

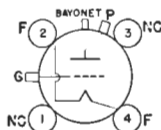

GL-806 GL-810
GL-8000

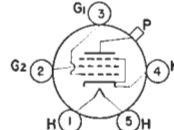

GL-807

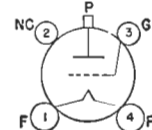

G-811A GL-812A
GL-8005

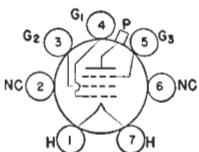

GL-813

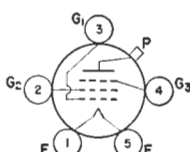

GL-814

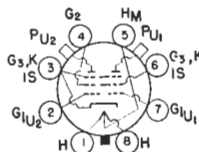

GL-815

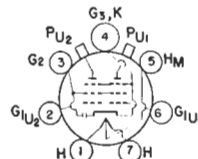

GL-829B GL-832A

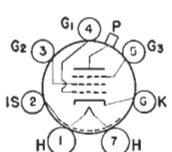

GL-837

KEY:

Bc—Base Sleeve. F—Filament; Fm—Filament center-tap; G—Grid; H—Heater; Hm—Heater center-tap; Is—Internal Shield; K—Cathode; NC—No connection; P—Plate; S—Shell; U—Unit.

TEST II Static Characteristic Test

IIA

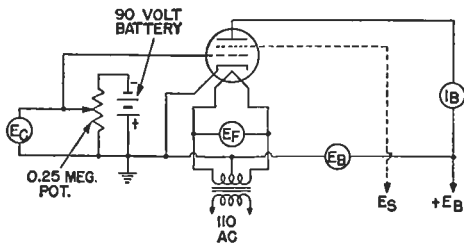

Fig. 1. Circuit diagram for static characteristic test set.

INSTRUCTIONS:

Apply filament voltage as shown in column 1; wait five minutes. Adjust grid bias to value half-way between those shown in column 4. Apply E_B and E_S . Readjust grid bias until I_B value is as shown in column 3. Read value of E_C on meter. Tube is "good" if this voltage falls inside the range indicated in column 4.

Column Number	1	2	3	4	5	6
Tube Type	E_F a-c volts	E_B d-c volts	I_B d-c ma.	$-E_C$ d-c volts	E_S d-c volts	Notes
GL-2E26	6.3	300	30	15/25	160	
GL-4D21/4-125A	5.0	1500	50	35/65	350	
GL-4-250A/5D22	5.0	2500	70	65/90	500	
GL-35T	5.0	1000	35	0/20	...	
GL-100TH	5.0	2000	40	20/50	...	
GL-806	5.0	1500	100	50/80	...	
GL-807	6.3	500	50	15/25	250	
GL-812A	6.3	1000	50	10/20	...	
GL-815	6.3	400	20	20/35	200	A
GL-829B	6.3	400	40	10/20	200	A
GL-832A	6.3	400	20	25/40	250	
GL-8005	10.0	1000	50	20/40	...	

IIB

INSTRUCTIONS:

Apply filament voltage as shown in column 1; wait five minutes. Set grid bias to value given in column 4, and apply E_B and E_S . Read I_B . Tube is "good" if this current falls inside the range of values indicated in column 3.

Column Number	1	2	3	4	5	6
Tube Type	E_F a-c volts	E_B d-c volts	I_B d-c ma.	$-E_C$ d-c volts	E_S d-c volts	Notes
GL-203A	10.0	1000	85/155	0	...	
GL-211	10.0	1000	55/85	50	...	
GL-592	10.0	2000	40/60	50	...	
GL-805	10.0	1500	60/100	0	...	
GL-810	10.0	2000	45/65	35	...	
GL-811A	6.3	1600	0/30	0	...	
GL-813	10.0	2000	35/65	35	400	
GL-814	10.0	1250	30/48	20	300	
GL-837	12.6	350	0/30	20	200	B
GL-838	10.0	1250	40/70	0	...	
GL-8000	10.0	2000	40/75	90	...	

NOTES:

- A. For one section only. The grid of the section not being tested should be connected to the negative terminal of a 90-volt battery, and the positive battery terminal connected to the common cathode.
- B. This tube requires a suppressor voltage during test. Connect +45 volts to the suppressor grid (pin 5). The negative voltage return goes to the cathode (pin 6).

TEST IIIA 14 Megacycle Power Oscillation Test

INSTRUCTIONS:

Apply filament voltage as shown in Column 1. Wait five minutes. Apply plate and screen voltage (be sure dummy load is in place). If grid current is not as specified in column B, change tap on coil until value is correct. Change output coupling till plate current is as shown in column 5. Recheck grid current. Reduce filament voltage until output drops 10%. Read filament voltage. Tube is "good" if filament voltage is equal to or less than value shown in column 7.

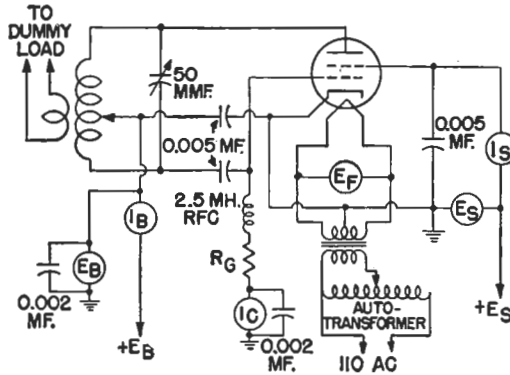

Fig. 2. Circuit diagram for power oscillator test set.

Column Number	1	2	3	4	5	6	7	8
Tube Type	E_F a-c volts	R_G ohms	I_C d-c ma.	E_B d-c volts	I_B d-c ma.	E_S d-c volts	E_M a-c volts	Notes
GL-4D21 /4-125A	5.0	15,000	10	3000	100	350	4.5	
GL-4-250A/5D22	5.0	15,000	8	3000	200	500	4.5	
GL-35T	5.0	3,000	40	1500	120	...	4.5	
GL-100TH	5.0	4,000	50	3000	150	...	4.5	
GL-203A	10.0	5,000	25	1250	175	...	9.0	
GL-211	10.0	5,000	30	1250	175	...	9.0	
GL-592	10.0	5,000	45	3000	200	...	9.0	
GL-805	10.0	5,000	57	1500	210	...	9.0	
GL-806	5.0	10,000	50	3000	200	...	4.5	
GL-810	10.0	5,000	50	2000	250	...	8.8	
GL-811A	6.3	3,500	40	1500	150	...	5.7	
GL-812A	6.3	3,500	40	1500	150	...	5.7	
GL-813	10.0	10,000	12	2000	180	400	9.0	C
GL-814	10.0	8,000	12	1250	150	300	9.0	D
GL-838	10.0	5,000	55	1250	175	...	9.0	
GL-8000	10.0	8,000	38	2250	275	...	8.8	
GL-8005	10.0	5,000	35	1500	200	...	9.0	

NOTES: C. Screen current on "good" tube should be between 25 and 55 ma.
D. Screen current on "good" tube should be between 15 and 30 ma.

Test IIB Limited Peak Emission Test

INSTRUCTIONS:

Apply filament voltage as shown in column 1. Wait five minutes. Use battery indicated in column 2 for anode supply. Turn switch on and as soon as meter in anode circuit comes to rest, make a mental note of I_T and turn switch off. If switch is on for more than four seconds you may damage the tube. A new tube is "good" if I_T is greater than the value indicated in column 4. A used tube still has some life left if I_T is greater than the value shown in column 3. Any value of I_T greater than that shown in column 3 indicates a usable tube.

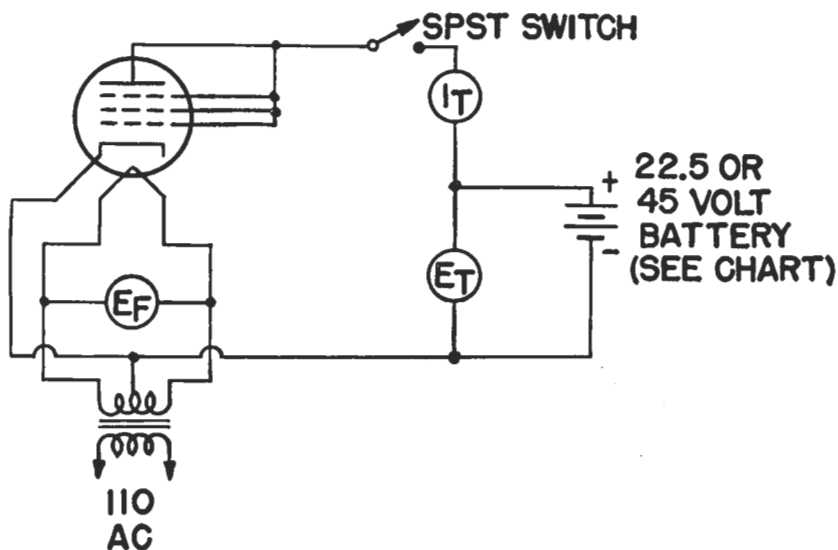

Fig. 3. Circuit diagram for limited peak emission test.

Column Number	1	2	3	4	5
Tube Type	E_F a-c volts	E_T d-c volts	I_T d-c ma.	I_T d-c ma.	Notes
GL-2E26	6.3	22.5	85	110	
GL-807	6.3	45.0	190	255	
GL-815	6.3	22.5	85	110	E
GL-829B	6.3	22.5	160	215	E
GL-832A	6.3	22.5	50	70	E
GL-837	12.6	22.5	65	85	

NOTES:

E. For one section only. The grid of the section not being tested should be connected to the negative terminal of a 90-volt battery, and the positive battery terminal connected to the common cathode.

SWEEPING *the* SPECTRUM



Good news on the G-E *Ham News* bound volume! By the time this issue appears the bound volume will be available. Those of you who sent in votes or comments on the bound volume should have received a personal note by this time stating that a copy has been set aside for you. The quantity bound will be sufficient to take care of all those who voted "yes" plus a few others who did not bother to vote. However, the edition is limited, and except for the volumes being held for those who voted, the rest will go out on a first-come, first-served basis.

Here are the details. The G-E *Ham News* Bound Volume is a cloth-bound book containing 214 pages. Included are all issues of the G-E *Ham News* from Vol. 1, No. 1, through Vol. 5, No. 6—that is, from the May-June 1946 issue to the November-December 1950 issue. The price of the book is \$2.00, postpaid. Orders should be sent to Lighthouse Larry, Tube Division, Bldg. 267, General Electric Co., Schenectady 5, New York. Remittance (check or money order) should be made payable to General Electric Company. This offer applies only in continental U.S.A., Alaska and Hawaii. Be sure to include your name and address.

That wheeze about being sure to include your name and address is not just something to fill up space. You might be surprised if you knew how many letters I get in which the writer forgets to put his full name, or his address, or even his call. We even look on the envelope and are disappointed in some cases. If the call is included we are all set because we have a copy of the *Radio Amateur Call Book*, but without the call, or the address, there is nothing we can do but throw the letter away.

Also, if the name and address is typed, or printed, it is much easier to read. Some letters come in with a hand-written signature and address which we may not be successful in deciphering. Letters of this sort are the exception, of course, but you can help me to answer your letters if you remember to give your name and address so I can read it.

A *Ham News* reader recently wrote me and complained about the length of my address. He said that by the time he got through writing "Lighthouse Larry, Tube Divisions, Electronics Department, Bldg. 267, General Electric Company, Schenectady 5, New York" he didn't have any room in the letter to ask his question. I regret that my correct address is so lengthy, but there is a good reason for it.

The Schenectady plant of the General Electric Co. is the largest of its many plants. It covers an area about a mile long and slightly less than a mile wide. A good many people work in this area. As a matter of fact, G.E. has its own internal bus system, its own hospital, an efficient fire fighting department, several power generation plants, and even a truck system to distribute mail from building to building. It is really a city all by itself.

The mail system in our "city" must have my correct address, because I am not known personally to the mail clerks. If you are in a hurry when writing to me, you may use my shortest correct address, which is: Lighthouse Larry, Bldg. 267, General Electric Co., Schenectady 5, New York.

This issue of the *Ham News* starts off the sixth consecutive year of publication. The past thirty issues have brought you such items as the R-9'er, the Guillotine Converter, the Megabooster, the Single-Sideband Adapter, the Lazy Linear, the Harmoniker, the E-P Rig, the Logarithmic Compressor, the SSB, Jr. and the TVR Filter. It is your editor's hope that the next thirty issues will bring you at least as many ham hits.

Now under construction or in process of design are such things as a five-tube single-sideband receiver adapter, a specialized six-meter receiver, a versatile yet economical oscilloscope, and several other items which are still just doodles on the design board.

If you are interested in these units, be sure to get your copy of the G-E *Ham News* regularly at your nearest G-E Transmitting Tube distributor—or join our rapidly growing list of subscribers.

—Lighthouse Larry

R-F POWER INDICATOR

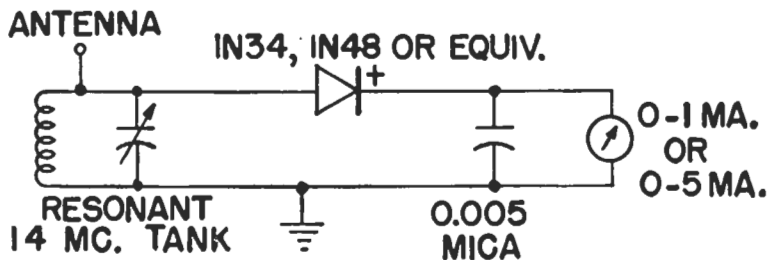

Fig. 4. Circuit diagram for germanium diode r-f power indicator.
This unit is used in conjunction with Test III-A.

Fig. 4 gives the circuit diagram for a simple power output indicator to be used in conjunction with Test III-A. It consists of a tank circuit, a germanium diode, and a d-c milliammeter. As shown, this instrument will not give a quantitative power reading, but it will read percentage changes in power, which is all that is required for Test III-A.

The inductance and capacitance in the tank circuit is not specified because almost any values will serve as long as the combination will tune to 14 megacycles — the frequency of the test set. Either a 0-1 or 0-5 milliammeter may be used, because sensitivity is not too important.

Build the power indicator in a metal box. The

ground connection shown in the circuit diagram does not particularly have to go to earth ground, but the metal chassis should be connected to the ground bus.

To use the instrument, place it as far from the transmitter as possible, in order that it picks up energy only from the test set (and not from driver stages, if they are used). Put an antenna on the indicator, and adjust the length of the antenna until the meter reads full scale. Now, when you wish to reduce the power by ten percent, lower the filament voltage in the test set until the meter reads 0.95 mils on the 0-1 milliammeter (or 4.75 mils on the 0-5 milliammeter). This current reduction represents a drop of ten percent in the output power of the transmitter under measurement.



Ham News

Available FREE from

G-E Electronic Tube Distributors

Printed in U.S.A.

A Bi-monthly Publication

TUBE DIVISIONS, ELECTRONICS DEPARTMENT

GENERAL ELECTRIC

SCHENECTADY 5, N. Y.

(In Canada, Canadian General Electric Company, Ltd., Toronto, Ont.)

GEO. H. FLOYD, W2RYT—EDITOR

FROM: